

SECTIA PROFILARE TABLE SUBTIRI (PT) - dispune de o serie de utilaje pentru prelucrarea tablelor din otel, aluminiu/aluminiu striat sau inox:

Abkant BIMA 8 m lungime cu comanda numerica Touch500 si foarfeca cu role pentru tabla plana de otel/aluminiu cu grosimi pana la 3,00 mm, respectiv inox pana la 2,00 mm.

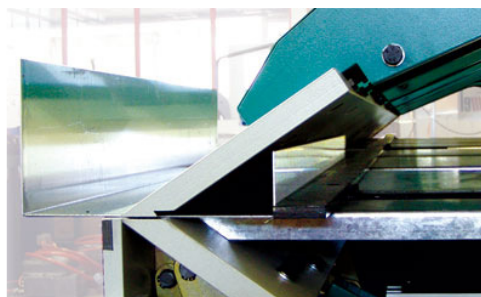

Masina de decupat colturi IMAC cu unghi variabil 30°-140° pentru tabla de otel pana la 4,00 mm grosime si abkant Schechtl 2 m lungime cu prisme si foarfeca cu role pentru tabla plana cu grosimea pana la 1,00 mm otel / 1,50 mm aluminiu / 0,70 mm inox



Structura usoara si/sau secundara:

- Z C U Σ Ω Z I C I U I,
- profile cu aripi inegale,
- socluri luminatoare,
- cadre usi/ferestre/P.S.

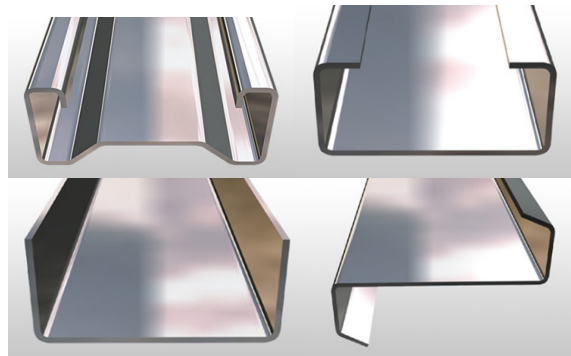

Profile inchidere:

- lacrimar, coltar exterior/interior, glaf atic, picurator/laterale ferestre/usi/porti sectionale

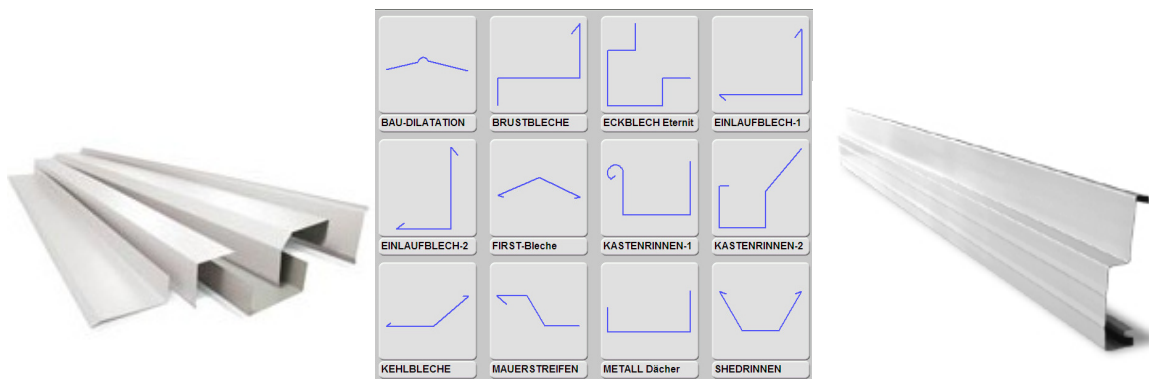
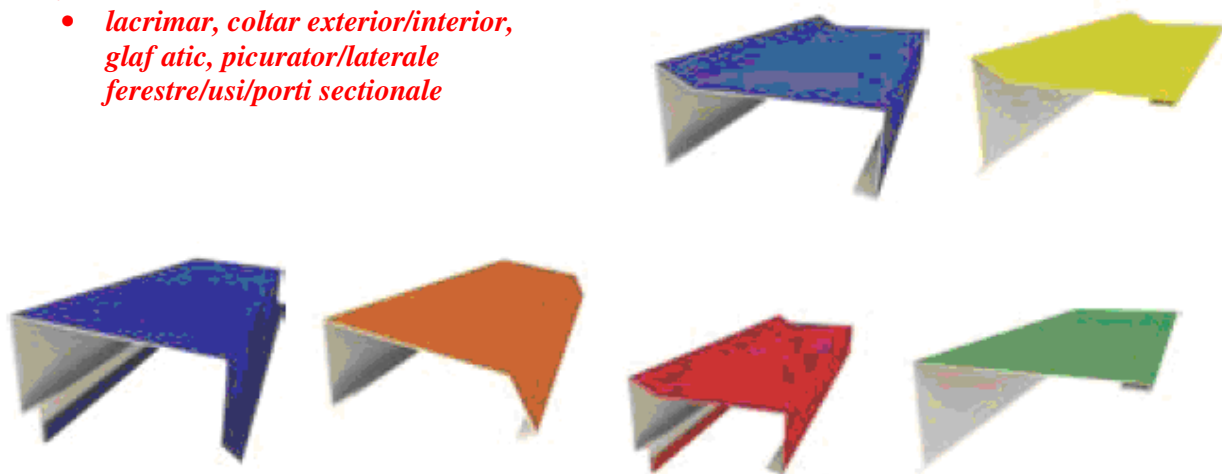

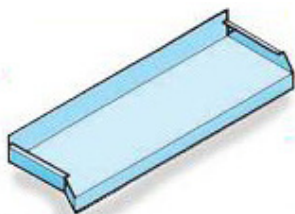

Profile pentru fatada curbe:

- profile „schroeder”
- accesorii industria alimentara

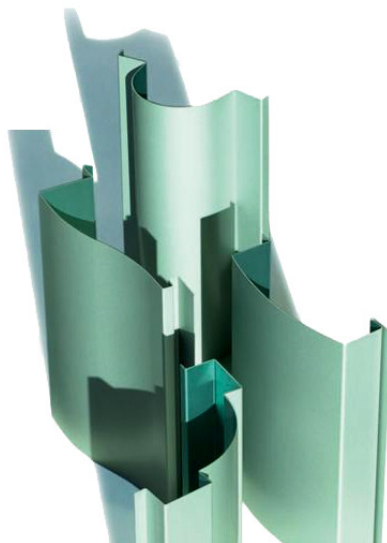

Jgheaburi si burlane cu sectiuni variabile pentru suprafete mari de acoperis din tabla zincata groasa 2,00-3,00mm sau din tabla vopsita RAL

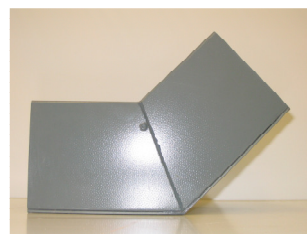
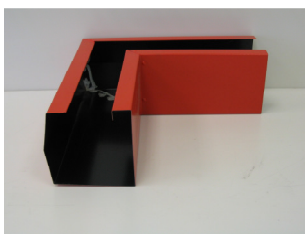
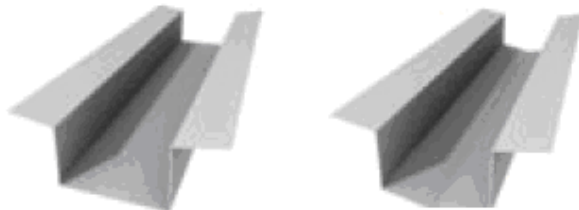

CASETE PENTRU FATADA

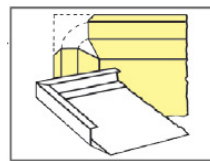
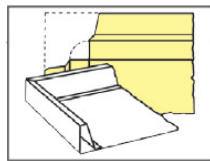
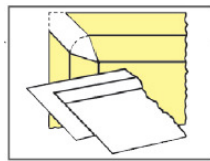
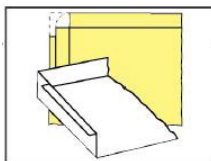

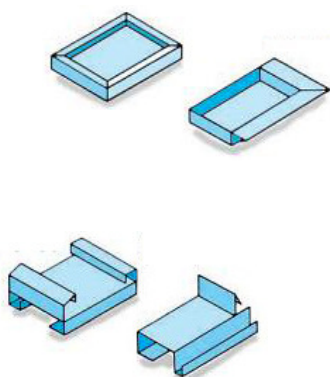

CADRE / CUTII METALICE

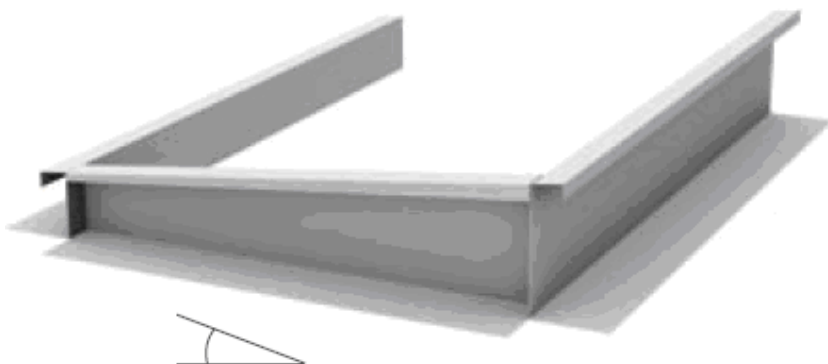

Nota: Pentru orice detalii, inclusiv consultanta pentru solutii tehnice si/sau ofertare va rog nu ezitati sa ne contactati.

Va multumesc.
Ing. Elena Popescu,

Mobil: 0752 299 707
Fax: 0248 610 330
E-mail: elena@masterbuild.ro
Web: www.masterbuild.ro